

Unclassified

DSTI/ICCP/CISP(2007)14/FINAL

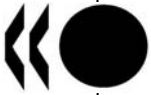

Organisation de Coopération et de Développement Économiques
Organisation for Economic Co-operation and Development

02-Jun-2009

English - Or. English

**DIRECTORATE FOR SCIENCE, TECHNOLOGY AND INDUSTRY
COMMITTEE FOR INFORMATION, COMPUTER AND COMMUNICATIONS POLICY**

**DSTI/ICCP/CISP(2007)14/FINAL
Unclassified**

Working Party on Communication Infrastructures and Services Policy

**ENUM: CONVERGING TELEPHONE NUMBERS AND ADDRESSES IN NEXT GENERATION
NETWORKS**

JT03265763

Document complet disponible sur OLIS dans son format d'origine
Complete document available on OLIS in its original format

English - Or. English

FOREWORD

The Working Party on Communication Infrastructures and Services Policy (CISP) discussed this paper at its meetings in December 2007 and finalised it in December 2008. The Working Party agreed to recommend the paper for declassification to the ICCP Committee. The ICCP Committee agreed to the declassification of the paper in March 2009.

The paper was drafted by Thomas de Haan, from the Ministry of Economic Affairs, The Netherlands, while on assignment to the OECD.

TABLE OF CONTENTS

ENUM, CONVERGING TELEPHONE NUMBERS AND ADDRESSES IN NEXT GENERATION NETWORKS	5
Main Points	5
INTRODUCTION	7
NUMBERING AND ADDRESSING IN NGN'S	8
The significance of telephone numbers and other addressing resources.....	8
Numbering developments in NGN.....	8
IP based addressing schemes.....	9
Proprietary addressing schemes	9
The challenge of divergence for users and providers.....	9
Where ENUM comes in	10
USER ENUM	11
The original protocol.....	11
The user in control.....	12
User ENUM deployments	12
The role of regulators	12
The future of User ENUM	13
ENUM FOR IP-INTERCONNECTION AND VOIP PEERING.....	14
VoIP driving changes in numbering.....	14
User ENUM is not an option.....	14
Carrier ENUM.....	15
INFRASTRUCTURE/CARRIER ENUM.....	15
Standardisation within IETF	15
Infrastructure ENUM.....	16
The choice of the domain	16
Embedding the ENUM mechanism in the architecture of NGN.....	17
NGN address translation in ETSI	18
The new GSMA service framework	19
ENUM IN THE VOIP MARKET PLACE	20
Private Carrier ENUM and VoIP islands	20
Bridging the VoIP islands	20
Federations and VoIP peering platforms.....	21
Federations of national operators.....	22
Platforms for VoIP interconnection and peering	22
The GSM Association (GSMA)	22

SUMMING UP ENUM	22
The characteristics of the ‘ENUM rule’	22
The suite of ENUM variants	23
The multiroot issue.....	24
PUBLIC POLICY ISSUES	24
Telephone numbering in NGN	24
Impact on telephone numbering policy	25
Number detachment.....	25
The life cycle of telephone numbers.....	26
Management of ENUM resources.....	26
Number Portability.....	26
Next Generation Number Portability platforms	27
Setting the standard for Infrastructure ENUM	29
Competition considerations.....	30
Privacy and the protection of personal data	30
Security	31
GLOSSARY	33
NOTES	35

ENUM, CONVERGING TELEPHONE NUMBERS AND ADDRESSES IN NEXT GENERATION NETWORKS

Main points

This paper provides an overview of developments in numbering, naming and addressing in the context of Next Generation Networks (NGN) with a focus on ENUM. ENUM comprises a diverse set of standards and non-standardised mechanisms for transforming public telephone numbers into unique domain names. The main conclusions of this paper include:

Numbering, naming and address translation

- Telephone numbers will remain as key identifiers for telecommunication services for the foreseeable future, despite the use of IP and the surge of new address schemes in NGN. Increased use of ENUM mechanisms could even prolong the lifespan of telephone numbering.
- Convergence and the shift to IP will accelerate ‘number detachment’ and will increase the pressure on regulators to further augment the flexibility of numbering plans, broaden the uses for existing number ranges, extend the possibilities of personal allocation to end users, and consider portability of telephone numbers between services.
- The uptake of ENUM as a non-standardised mechanism for translating telephone numbers to other addresses can first of all be seen in the VoIP interconnection market. In particular new VoIP carriers use Carrier ENUM in combination with SIP as an alternative for SS7, the Signalling System used in the traditional PSTN environment. The uptake of Carrier ENUM can also be seen in newly developed standards for the architecture of NGN, where it is the preferred but not only option to perform the translation function of telephone numbers to other addresses.
- ENUM, when used in networks as a mechanism for translating public telephone numbers into other IP-based identifiers, will enhance interoperability between the existing public switched telecommunication environment and new Internet Protocol based environments, therefore helping providers and users continue to use telephone numbers in NGN.

User ENUM and Infrastructure ENUM

- Privacy and security risks are mainly associated with these public versions of ENUM, and are the result of the public exposure of data in the Internet: *personal* data in the case of User ENUM and *interconnection* data in the case of the (proposed) Infrastructure ENUM standard. For User ENUM improved authentication mechanisms preventing misuse of data (spoofing, ID theft, etc.), such as DNSSEC and other solutions, are the most effective tools to overcome these risks.

- The deployment of User ENUM is limited to eight countries and characterised by slow growth, and there are no indications that this growth will suddenly accelerate. While some argue that there is no viable commercial market for User ENUM, advocates argue that it may still take some time for the right conditions for User ENUM to prosper.
- Finalisation and deployment of the Infrastructure ENUM standard will depend on discussions between IETF and ITU. Meanwhile continuing growth can be expected in the use of non-standardised variants of ENUM in the market place, such as Carrier ENUM.

VoIP interconnection

- The combination of IP, DNS and the ENUM mechanism is, amongst other solutions, an effective tool for market parties to set up databases with VoIP interconnection data and exchange this information with trusted partners.
- Increasingly telecommunication providers are grouping into federations, agreeing on a shared approach for VoIP interconnection and enabling settlement free peering between themselves. Connectivity between federations, the bridging of the 'VoIP islands' is currently a significant challenge for the market, as centralised data for the termination of VoIP calls are lacking.
- This federated model might introduce competition and interoperability risks in the VoIP market, if providers outside federations face barriers to interconnect. An open, fair and competitive communications market could therefore benefit from transparent and non-discriminatory conditions for access to VoIP interconnection data, in analogy to the access to number portability data in most OECD countries.

Number portability

- Mobile operators and other market parties have expressed the need to adapt number portability arrangements to incorporate VoIP interconnection data. The ENUM mechanism is a useful tool to set up these databases segmented on national lines, therefore becoming an issue of national scope. Depending on national conditions and specific regulatory provisions on number portability, regulators could co-ordinate or co-operate with industry in setting up 'next generation' number portability platforms.

INTRODUCTION

The OECD Document “Convergence and Next Generation Networks”¹ analysed developments in Next Generation Networks (NGN), and the convergence of core and access networks. The aim of that paper was to review areas where policy changes may be required and to put forward recommendations for considerations in areas where change may be necessary to support new developments and to ensure that telecommunication policy goals can be met.

The paper depicted areas of regulatory interest, arising from the deployment of NGN. The objective was to identify policy and regulatory issues that government and national regulatory authorities may have to confront in the framework of the development of core next generation networks. It noted that the issue of ‘Numbering, naming and addressing’ was a policy area that would need further analysis and that ENUM was one of the potentially significant developments in the converging world of telephone numbering, naming and addressing.

ENUM comprises a set of standards and mechanisms for transforming public telephone numbers into unique domain names to be used in NGN, enabling providers and users to continue to use telephone numbers which is beneficial for the shift from the existing public switched telecommunication environment to an Internet Protocol based environment and for the integration of new IP multimedia services.

Different ENUM implementations exist in the market place. While they are all named ENUM, their purpose and use are not comparable and independent. A clear distinction has to be made between two main categories:

- *User ENUM*, also referred to as public ENUM, has the aim to give the end user (the holder of a telephone number) control over his communications. It allows end users to opt-in with their existing telephone numbers to provide other users with the capability to look up contact details that the user has linked to his number on the Internet. User ENUM was conceived as the global, public directory-like database marrying the telephone numbering system with the Internet.
- *Infrastructure ENUM* or *Carrier ENUM* support routing and interconnection of calls. It is used between (groups of) carriers with the purpose of sharing subscriber information in peering relationships. In this case the carriers themselves, not the end users, control subscriber information. These implementations are also referred to as private ENUM when carriers or VoIP providers use ENUM only in their own network.

NUMBERING AND ADDRESSING IN NGN'S

The significance of telephone numbers and other addressing resources

Telephone numbers, domain names, IP addresses, and other addresses are crucial resources for communication and access to the market. They provide operators and service providers the necessary data for locating and identifying customers and network points in order to deliver their services. For users they provide a presence in the world of communication and a means to communicate with others. For the PSTN, the public switched telephone network, the telephone numbering system, according to the ITU-T recommendation E.164, is the main mechanism to address end users, together with recommendation E212 for mobile subscribers.² Practically all wire line and wireless network operators base their interconnection, interoperability and service provisioning on the telephone system. Also with the take up of mobile telephone and NGN, E.164 continues to be the dominant scheme within voice communication to identify and connect subscribers.

Telephone numbers have characteristics with specific benefits in future networks succeeding the PSTN, despite having the disadvantage of not being supported in the core IP networks. The E.164 telephone numbering scheme guarantees uniqueness, because of its unambiguous top-down hierarchy based on national segmentation, and it can be easily expanded by introducing new ranges. Furthermore the use of numeric digits makes telephone numbers easy to manage in networks and culturally and linguistically neutral. Because of the regulated management and allocation of numbers, providers can rely upon reliability and long-term stability of the acquired resource, equally important to end users. Another characteristic of telephone numbers is that, due to the signalling system behind and the visibility to end users, they could better be considered as "names" or "labels", comparable to Internet domain names, while IMSI numbers are more comparable to the functions of an "address" such as an IP-address.

Numbering developments in NGN

The same developments that characterise the merging ICT landscape are impacting on addressing as well, such as the migration to IP, the separation of the network and services layers, the development of new (multimedia) services, and continued liberalisation. In an OECD Foresight Forum "Next Generation Networks: Evolution and policy considerations"³ in 2006, several participants referred to numbering and addressing as a critical factor when deploying NGN's. Some of the notions expressed in this Forum are:

- The challenge is to take the best of both telephony and Internet worlds. From the Internet world NGN will take IP transport, addressing and naming, presence and messaging services, while from the telephone world it will take numbering, mobility, broadband and voice services.⁴
- In the transition to core NGN, operators will need to deal with changes in the interconnection regimes, relocation of existing assets, and with new technical requirements, such as standards, quality of service across networks and numbering issues.⁵
- There are risks involved with the NGN model. The capability of NGN to allow unfettered access for users to competing service providers and/or services of their choice might not be achieved if the resolution between both addressing systems used (telephone numbers in PSTN, and IP addresses, Domain Names and Uniform Resource Identifiers (URIs) in Internet) is not properly addressed with global standardisation.⁶

IP-based addressing schemes

The IPv4 addressing scheme⁷ as used in the Internet has been universally embraced by NGN networks as the core new addressing scheme, in combination with the overarching TCP/IP protocol suite.⁸ IP addresses are used ‘under the hood’ within networks and determinate network points; using an IP address will always lead to a uniquely defined network point, although not necessarily the end point.⁹ On top of IP addressing there are naming and translation mechanisms, such as the DNS (Domain name System) that map or add other identifiers to an IP address. These identifiers, such as domain names, e-mail addresses and SIP addresses¹⁰, are more comparable to telephone numbers, as they are used at the edges of networks, in the higher layer where services and applications take place in interaction with users. Abstracting the IP architecture one could say that providers and end users communicate using domain names, email addresses and SIP addresses, while the ‘omnipresent’ IP addresses are used in the lower physical layer of networks for transport.

With the expansion of the public Internet, the use of domain names and e-mail addresses for end users, have become worldwide common practice, comparable to the worldwide expansion and acceptance of the telephone numbering system. Increasingly the underlying general format used in IP networks is the URI, the Uniform Resource Identifier. The URI is evolving into the main intra-network identifier and basically defines an ‘identity – service’ combination in a format like scheme:user@host or scheme:identifier@domain.tld. The URI format is versatile and, next to the well known URI for e-mail (mailto:user@domain.tld), the URI for SIP (sip:user@host) is becoming a main identifier to address VoIP subscribers according to the SIP protocol. These types of identifiers are all IP-based and can eventually be traced back to an IP address.

Proprietary addressing schemes

In parallel, other more closed identifier schemes have been introduced mainly with the emergence of web based VoIP and instant messaging (IM). Internet-focused companies such as eBay (Skype), Microsoft, Yahoo, Google and AOL have added voice, IM (instant messaging) and video capabilities to their software, serving large communities. They route mostly on the basis of ‘end to end point’ communication, having the advantage that traffic does not need to be routed through the PSTN’s traditional switches, or via SIP gateways as used within VoIP. These highly competitive providers on the voice market manage their subscribers’ identities with proprietary schemes¹¹ and employ telephone numbering only when interoperability is needed with subscribers outside their community (Skype-in).

There is a key difference between the proprietary schemes and the earlier described IP based schemes. Although implemented on a provider-by-provider basis, IP-based schemes follow a standardised format and can be in principle supported across other networks. Interoperability is feasible if the right conditions are met, *i.e.* agreement between providers. Although some of the Internet-focused companies differentiate their service offerings and enlarge coverage, *e.g.* by forming strategic alliances with content providers (video or game) and broadband access providers, the interoperability outside the remit of their communities basically remains untouched. The absence of interoperability is sometimes seen as a deliberate customer ‘lock in’, as concluded by some parties on the basis that *e.g.* Skype will not map their end users to URI’s, and the introduction of IP telephones that cannot be used for other than the application provided by the IP telephony provider.

The challenge of divergence for users and providers

Telephone numbers by which PSTN subscribers are identified may eventually evolve into alternative names and addresses, but generally many new services, such as web-based IM and VoIP services, are used ‘on top’ of the regular voice subscription and this does not lead to the substitution of telephone numbers.

The emergence of new addresses, however, does lead to increasing divergence, as users are collecting more numbers and identifiers in different schemes, but there are no real indications that this divergence is posing problems on the end user side; end user equipment is becoming more intelligent and capable of handling multiple addresses and managing contact details.

The divergence however, does pose a challenge for providers. A study from Cullen/Devoteam Siticom for the European Commission in 2003¹² examined the regulatory implications of the introduction of next generation networks. It concluded that network operators (telecommunication, data, broadband) are facing three major technology developments and trends impacting on the migration of existing networks to NGNs:

- i).* Development in access technologies to support broadband services/content.
- ii).* Service provisioning through API's, Web services, offering key control points, Web Services (XML-based APIs).
- iii).* Interworking of addressing systems.

Regarding the interworking of addressing systems Cullen concludes; “convergence towards NGNs requires the interworking of the different naming, addressing and numbering systems. This includes the traditional public telephony E.164 numbers, Internet names (e-mail addresses or website addresses), IP addresses and Instant Messaging identifiers. Several solutions are being proposed for the mapping and interworking of these names and addresses, ENUM¹³ is one of them¹⁴”.

Where ENUM comes in

Telephone numbers in their standard format are not supported in the core NGN networks based on IP, where generally the URI format or other IP-based identifiers are used (see section on ‘IP based addressing schemes’ above). Still, for users as well as for providers, being able to continue to use telephone numbers is considered crucial for the shift from the classic telephone service to Internet telephony (VoIP¹⁵) and for the integration of new IP multimedia services. User ENUM¹⁶, a standard developed by the IETF¹⁷ was conceived for this purpose; it offered a mechanism for transforming public telephone numbers into unique domain names. While solving the mapping problem, it introduced potential new applications, as a result of the insertion in the Domain Name System.

USER ENUM

The original protocol

User ENUM is the original concept of a global, public directory-like database, with subscriber opt-in capabilities and delegation at the national level in a national Internet domain zone (the e164.arpa domain). User ENUM is mainly referred to as “public ENUM”. The scope of RFC¹⁸ 3761¹⁹ is defined as “the use of the Domain Name System (DNS) for storage of E.164 numbers and how DNS can be used for identifying available services connected to one E.164 number”²⁰. A very simple mechanism is used to create unique images of telephone numbers as shown in Figure 1.

Figure 1: the ENUM conversion mechanism

Step 1	Take a telephone number	+31 0123456789
Step 2	Reverse and add dots	9.8.7.6.5.4.3.2.1.0.1.3
Step 3	Add the domain e164.arpa	9.8.7.6.5.4.3.2.1.0.1.3. e164.arpa

The mirror of the telephone number, detached from its original PSTN function, now has the attributes of a domain name. A feature of ENUM is the association of data to the ENUM domain name. These so called NAPTR (Naming Authority Pointer records) can be used to specify all data necessary to identify available services connected to the individual ENUM domain. The NAPTRs containing service preferences can easily be queried from the public Internet in order to start communication sessions according to the preferences found in the additional data. NAPTR records can be stored on the registry level (tier 1) or on a lower level at the registrar level (tier 2) enabling decentralised architecture with distributed ENUM databases. When the ENUM standard was conceived, this powerful mechanism held the promise of a radical shift from PSTN to ‘all IP’, leveraging upon the huge installed base of subscribers using telephone numbers without having to engage in disruptive changing of addressing. Figure 2 shows how a call is set up by ENUM.

Figure 2: Example of communication set up with ENUM

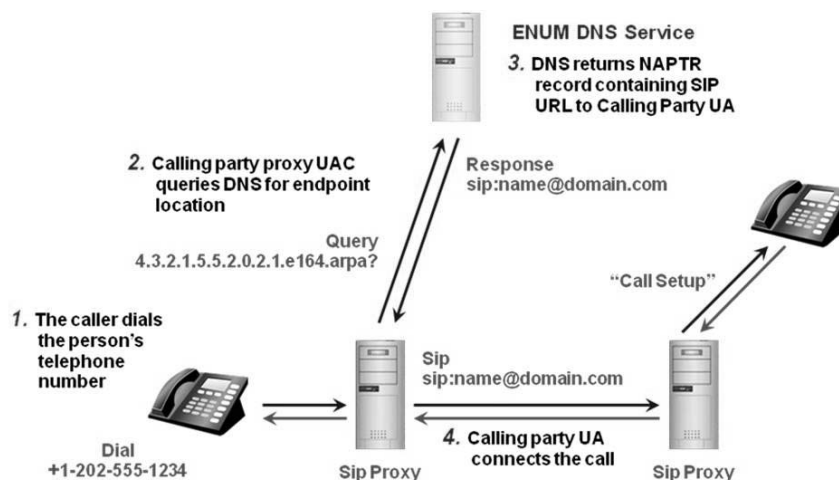

Source: Richard Shockey²¹

The scope of RFC 3761 is explicitly targeted at public telephone numbers allocated according to the ITU-T recommendation E.164 and the sole use of the e164.arpa domain, but it anticipates on broader use of the ENUM conversion mechanism in other areas.²² It prescribes that ENUM used in private dialling plans must not be called ENUM, should use another domain, and furthermore the telephone number entered should not carry the leading '+' character. Despite these demarcations, in practice all ENUM derivatives, using the simple rule enabling to relate a domain to a telephone number without any risk of ambiguity, are nowadays referred to as ENUM or the ENUM mechanism. This has led, and still is leading to confusion, given the varying and non-comparable uses of the ENUM.

The user in control

Although not officially named as such, RFC 3761 has become known as User ENUM, as the aim is to give the end user, *i.e.* the subscriber or holder of a telephone number control over their ENUM entries. The basic idea is to allow users to opt-in with their existing telephone numbers to provide other users with the capability to look up contact details on the Internet that the initial user has linked to his number. RFC 3761 leaves all policy decisions regarding registration and use of ENUM names to the registry of the ENUM zone, such as the choice of an opt-in mechanism. The user-centric approach though has led to the use of opt-in mechanisms in almost all User ENUM deployments, be it by self regulatory registries or regulators.

User ENUM deployments

User ENUM is being deployed on a national basis²³ and case by case following the instructions as agreed between the Internet Architecture Board (IAB) and ITU.²⁴ Since 2002 approximately 45 national registries have successfully applied for the delegation of the User ENUM zone of their country. Despite the large number of delegees, only 8 registries are 'in production phase' and less than 1 million telephone numbers are now entered in User ENUM²⁵, which is still very low compared to more than 4.5 billion allocated telephone numbers world wide.

The role of regulators

The role of regulators in the deployment of User ENUM varies, and depends very much on the national approach taken by the market and the regulator. Being an Internet resource, the functional

delegation takes place according to the rules applicable to the Domain Name System.²⁶ In the case of User ENUM the appointed delegee for the ENUM zone (*e164.arpa*) is RIPE/NCC, who acts on demand whenever an application is being made for an underlying zone (e.g. *3.3.e164.arpa* for France).

The application to become a registry follows the standard self-regulatory process within the Internet, with one major exception. The instructions agreed upon by ITU and IAB demand that the corresponding ITU Member State be consulted. The process provides for both active and passive involvement of an ITU Member State. The basic rule is that an application will be granted if the concerned Member State formally approves it. However if the Member does not react within a certain period, it will be understood as a non-objection and the delegation procedure will continue according to the instruction. The instruction seems to be a workable way for the deployment of User ENUM in both countries which favour User ENUM to be taken up under regulatory control or by self regulation. A myriad of models have arisen, some purely regulatory, but mainly private or in the form of a public-private co-operation. It is to be noted that in most countries where the User ENUM zone has been delegated to purely private parties, some form of relationship with the government exists, be it formal (through a contract or MoU) or informal.

From the market side the dominant role of ccTLD registries picking up User ENUM and initiating trials is remarkable. The User ENUM zone can be seen, just as the ccTLD zone, as a national Internet zone, and many registries see User ENUM as a natural expansion of their existing tasks, and feel it is a duty to their community to manage it accordingly.

The future of User ENUM

More than seven years ago, when User ENUM was conceived, it was thought to be the universal solution marrying the telephone numbering system with the Internet, and the vision of User ENUM was that of a 'global public directory' to which individual subscribers could opt-in. This expectation however has not come into fruition. The slow uptake of User ENUM has been attributed to many factors. There are obvious external factors that complicate the deployment of User ENUM such as the fragmentation along the lines of national borders and the dependency on the national regulator, but the concept itself of User ENUM has also been under attack. The argument of Carrier ENUM or Infrastructure ENUM being competing protocols (see following sections) is irrelevant as purpose and use are independent.

One of the factors most mentioned as impeding massive take up of User ENUM is the 'chicken-egg' situation between the ENUM registration services and the services using ENUM. Meaning that, as long as few registrations are made in User ENUM, there will be no incentive for the introduction of services using User ENUM, and vice versa. To break out of this technology push situation either a killer application would be needed, or some form of accelerated registration. There are few indications up to now that either option will occur. The ISP community (Internet Service Providers) has often been viewed as having 'high potential' to stimulate User ENUM since they have a vast installed base of Internet users, who could profit from User ENUM registration. Many ISPs though are controlled by incumbent carriers and engaging in User ENUM could lead to conflict of interests when users circumvent the PSTN through User ENUM. The issue of privacy (see section on privacy below) has been seen as a major barrier for User ENUM since its conception, but the concerns about privacy seem to have diminished, as in most User ENUM deployments there is a controlled policy set in place to comply with privacy regulation and overcome privacy risks.

The slow uptake of User ENUM however is not regarded as a failure by all parties; especially within the Internet community User ENUM is still regarded as having a big potential. The Internet has shown a long history of slow initial deployment of technologies that can not directly be linked to revenue or technical gain for the organisation 'doing the work', such as ENUM registries and voluntary organisations. Some note that certain new technologies, while initially embraced by few users, experienced a big rise in the number of users after 5 to 10 years or more²⁷, while others note that most dominant technologies had

their breakthrough within 5 years after development.²⁸ Advocates argue that it may still take time for the right conditions for User ENUM, as the assumption is that over time empowered Internet users and companies will take communication services under their own control. Given the current market conditions however, it is not probable in the near future that the current low growth will suddenly accelerate.

ENUM FOR IP-INTERCONNECTION AND VOIP PEERING

VoIP driving changes in numbering

The merging VoIP market is the main catalyst for developments in the area of convergence of numbering, naming and addressing. It is estimated that VoIP will probably account for 90% of the telephony market by 2009, and by 2015 when most telecommunication operators have switched off their fixed PSTN networks all voice calls will be *de facto* VoIP calls. According to Infonetics²⁹ the main drivers for carriers adopting VoIP continue to be reducing opex (operational expenses), growing revenue and adding margin-rich services, all aided by an increasing broadband penetration and the maturation of next generation voice technology.

The growth in Voice-over-IP traffic has led to a new and rapidly growing market for IP interconnection and VoIP peering (see Box 2). New VoIP providers typically try to avoid public networks in transporting and terminating their IP-based calls. They interconnect on IP layers, bypassing the traditional expensive PSTN, through the public Internet or via their own IP-networks. The end game is the ability both to provide end-to-end IP connections for VoIP with improved quality and control, and to enable new services, such as video calling, that are not possible as long as VoIP calls traverse the public network and most customers still have a fixed or mobile phone which cannot handle the software required for VoIP.

Despite the high growth of VoIP in certain segments, the vast majority of telephone calls still take place between PSTN landline or wireless subscribers. New VoIP service providers thus face the problem that, although their networks are optimised for addresses used in the IP environment, the majority of their calls have to be terminated to standard telephone numbers. This is the environment where innovative solutions are being developed for routing and interconnection of IP originated calls to the PSTN and vice versa. The challenge is to process 'dialled digits' of standard telephone numbers into other addresses.

User ENUM is not an option

User ENUM is not a solution for telecommunication carriers and service providers to address routing and interconnection of VoIP calls for several reasons. The vulnerability as a result of exposing data in the public internet and corresponding security risks are often mentioned (see Box 1), although it remains to be seen whether commercial risks prevail, as other resources like domain names can also be queried publicly. The main factor however is the lack of control and management of the data entered in User ENUM. User ENUM is end user triggered; there are no guarantees that the data entered are complete, accurate, reliable and safe. Operators and providers thus cannot rely on a guaranteed QoS (Quality of Service) of their services and routing of calls.

Carrier ENUM

ENUM as a technology however, detached from its original user centric approach, has been embraced by many parties involved in managing VoIP calls (with the exception of web-based peer-to-peer VoIP calls), whether purely IP, such as VoIP providers building new all-IP networks, whether the legacy networks and the mobile world. Common to all these deployments of the ENUM mechanism is the fact that carriers (network operators and providers) will be in control and populate their databases with the call termination preferences related to their subscribers' telephone numbers, which is orthogonal to the idea of user ENUM (see Figure 3). The use of the ENUM mechanism as a means to enable intelligent routing and termination of calls between networks between carriers and providers has been taken up in several ways. While efforts take place to standardise ENUM for carriers, called *Infrastructure ENUM* many private forms are being deployed today in the market place, called *Carrier ENUM* or *Operator ENUM*. In general *Carrier ENUM* or *Operator ENUM* is also referred to as *private ENUM* when a carrier, VOIP operator or ISP uses ENUM techniques within its own networks. For reasons of clarity only the term *Carrier ENUM* is used in this report for this purpose

Figure 3: User ENUM versus Infrastructure/Carrier ENUM

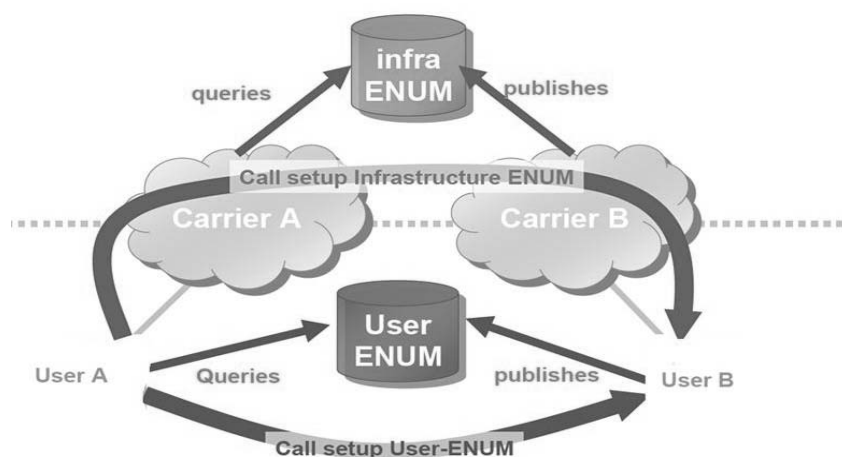

Source: Geoff Huston³⁰

INFRASTRUCTURE/CARRIER ENUM

Standardisation within IETF

Infrastructure or Carrier ENUM is the ENUM implementation when groups of carriers or communication service providers agree to share subscriber information via ENUM in private peering relationships. In this case, the carriers themselves, not the individuals, control subscriber information. While standardisation of the architecture of NGN takes place in several fora (see further in this section), it is the IETF who has the lead in ENUM standardisation, whether user oriented or carrier oriented. IETF has three working groups dealing with topics involving ENUM:

Working Group ENUM

- The activity focuses on the discovery of addresses through ENUM. Among the releases of this group is RFC 3761, the first standard defining User ENUM. The WG submitted early 2007 a set of documents on Infrastructure ENUM to the IESG for approval. This will be covered in the next section.

Working Group SPEERMINT

- This WG covers the applications area of ENUM. It is complementary to and strongly linked to the work of the first WG.

Working Group P2PSIP

- This WG, created in February 2007, is looking at standardising peer to peer SIP services. It is seen by many frontrunners as a promising activity, as P2P SIP is regarded as the next evolution in “Internet communication”, and the logical step replacing VoIP.³¹

Infrastructure ENUM

The IETF Working Group ENUM has finalised a series of documents on Infrastructure ENUM and submitted them to the IESG for approval as informational documents or proposed standards.³² These documents cover a substantial part of the protocols to be used and the technological choices to be made for Infrastructure ENUM. The principles defining Infrastructure ENUM can be summarised as follows:

- Infrastructure ENUM uses the RFC 3761 (“User ENUM”) technology to facilitate interconnection of networks for services addressed by standard telephone number, in particular but not restricted to VoIP.³³
- Infrastructure ENUM should be implemented in a dedicated domain, to be determined. It will be a parallel namespace to e164.arpa, the User ENUM domain^{32, 34}.
- The data entered in Infrastructure ENUM tree will be controlled by the service provider that is providing services to a given telephone number, generally referred to in various countries as the “carrier of record”. The definition of a carrier of record for a given E.164 number is a national matter or is defined by the entity controlling the numbering space.

The choice of the domain

One major issue remains unresolved; the choice of the domain in which Infrastructure ENUM should be deployed. While on the surface apparently not a complex decision, this issue has led to a fundamental debate within the IETF whether it is the appropriate body to take such a decision and whether the global public DNS should be used *at all* for the discovery of carrier to carrier points of interconnection (see Box 1). The chairs of the IETF ENUM Working Group have expressed their reluctance about IETF defining a specific domain, and stated that if such a domain were defined, it should be a result of discussions within ITU, the organisation authoritative for the E.164 telephone numbering plan.

Although the domains “i164.arpa” and “ie164.arpa” were frequently mentioned as candidates, no specific domain has yet been proposed in an IETF document as a long-term solution for Infrastructure ENUM, and the ball is in the hands of the IESG to initiate a liaison with the ITU SG2, with or without a predefined domain.

Box 1: Fundamental debate about public versus private ENUM

The question whether the global public DNS should be used for the insertion and discovery of carrier to carrier points of interconnection has led to a fundamental debate in which there are two opposing school of thought. In a way the debate reflects the 'bell head - net head' controversy on how interconnection is perceived; the 'bell heads' regard interconnection as a service related and provider controlled matter, while the 'net heads' see interconnection basically as open access at the IP level.

The school of thought taken which has taken root mainly among telecommunication carriers, believes that the global DNS is not appropriate for the publication of carrier to carrier points of interconnection. Mostly larger carriers are concerned that publication of points of interconnection in the global DNS could expose their networks to various forms of attacks that would compromise the quality and reliability of real time voice communications, such as SPIT, Identity theft, DDoS attacks, etc. Private ENUM implementations would not have these disadvantages while still leveraging on the potential of the ENUM mechanism. Infrastructure ENUM also could face latency problems³⁵, and furthermore it does not have the capability of alternative routing decisions, depending on the carrier involved with the routing, or the business relation between carriers.³⁶

The other school sees the public DNS as the logical place to solve global reachability on the IP level. The current implementations of private and federated ENUM have a major disadvantage: The reach is limited to numbers from providers participating in a federation. To enable global reachability, a single, common and global tree is required. This school has more affinity with the concept of the Internet as the platform for all communication, anticipating that voice communication will eventually evolve from a service into an application.³⁷ Global IP Interconnect via ENUM basically comes down to a 'global VoIP Peering regime', as points of termination can easily be accessed without further arrangements between providers.

Embedding the ENUM mechanism in the architecture of NGN

The development towards all-IP based networks is taking place in different fora. For traditional PSTN operators, including incumbents, migration is based mostly on European Telecommunication Standards Institute (ETSI)³⁸ and International Telecommunication Union (ITU)³⁹ standards and specifications. Independent ISPs continue to develop their multi-service potential relying more on Internet Engineering Task Force (IETF)⁴⁰ standardisation work. Mobile carriers are working to improve versions of IP Multimedia Subsystem (IMS) through the 3rd Generation Partnership Project (3GPP and 3GPP2).⁴¹ There is an intense co-operation between these bodies, as in the end all parties working on NGN share a common goal; connect the different NGN network layers (access, transport, control and services) through open and standardized interfaces, allowing services to travel across networks and providers, independent of the environment, wireless or wireline.

The specialised working groups on "naming, numbering and addressing" of ETSI and 3GPP have embraced the ENUM technology in the future architecture of NGN and made it one of the building blocks in the control layer of the NGN architecture (see Figure 4) taking the IETF documents, describing the core ENUM technology as a basis. The GSM Association⁴² (GSMA), though not a standardisation body, has integrated the ENUM mechanism in the design of its future service framework. The following sections clarify these initiatives.

Figure 4: NGN architecture

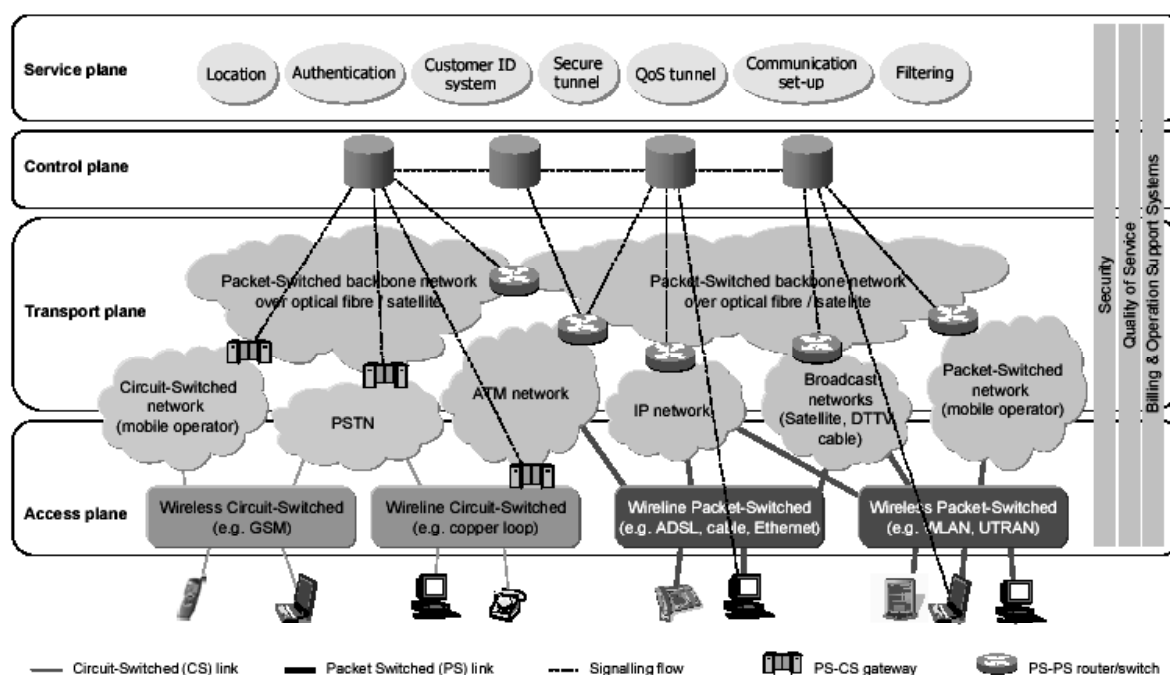

Source: ITU

NGN Address translation in ETSI

ETSI has a working group on naming, numbering and addressing within its Technical Committee TISPAN.⁴³ They released a technical report draft⁴⁴ in which the ENUM mechanism is positioned as one of the methods for translating telephone numbers into the identifiers used in advanced networks (see Figure 5). This draft report builds further on earlier reports identifying ENUM as a long-term solution for translating telephone numbers into other addresses. In an earlier report ETSI already differentiated Infrastructure/Carrier ENUM from User ENUM and concluded that User ENUM would not meet the requirements of carriers.⁴⁵ ETSI refers to ENUM as a “DNS translation mechanism based on IETF” and it seems that, while taking ENUM as a basic building block for NGNs, it leaves the standardisation part to IETF. Next to ENUM, however, also other translation techniques could be used.

Figure 5: Numbering and Addressing resolution in NGN's (abstracted)

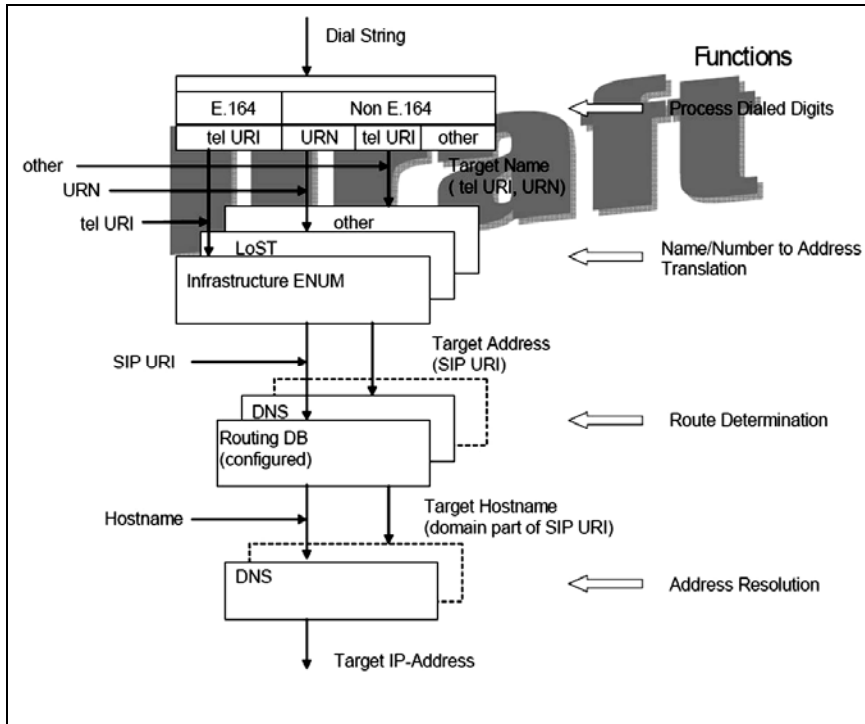

Source: ETSI

The new GSMA service framework

In their move to NGN the mobile operators associated in the GSM Association (GSMA) have made a set of technological choices to enable the networks of their members to interwork. Taking 3GPP standards defining the IMS “all IP” architecture as a basis, the GSMA has defined a service framework allowing interconnection and exchange of all IP communication, for the time being called IPX (IP Interworking eXchange). The rules and guidelines covering the aspects of interworking are documented in a newly revised technical document IR.67 DNS Guidelines.⁴⁶

IPX will utilise Carrier ENUM, deployed in a ‘single root ENUM’, the private domain *e164enum.net* for use by operators only and not connected to the public DNS. The ENUM database linked to the domain will eventually cover the 3 billion mobile subscribers within the reach of GSMA. Distributed ENUM databases should be set up nationally, according to the E164 numbering plan, and the ENUM databases will be available for global use by any operator, mobile or fixed, who is connected to the IPX. In the startup phase the IPX will mainly serve to support IMS and MMS services.⁴⁷

Figure 6: The GSMA Service Framework

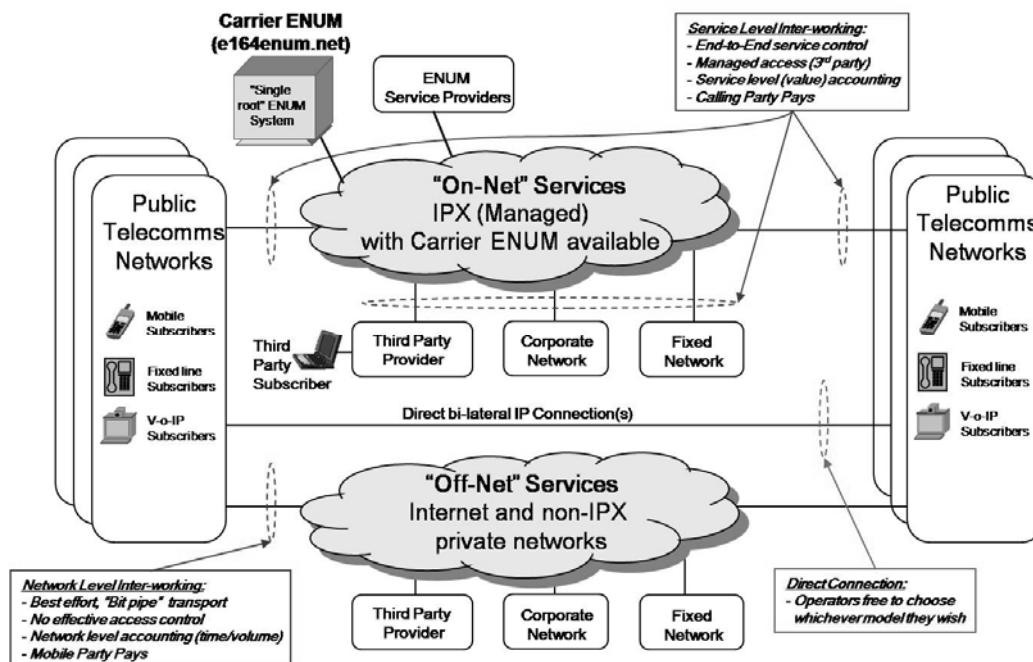

Source: GSM Association

ENUM IN THE VOIP MARKET PLACE

Private carrier ENUM and VoIP islands

Due to the continuing growth of VoIP, many private ENUM initiatives have emerged in the VoIP market place, without having had the time or the necessity to go with the standardisation process. The ENUM mechanism provides newcomers in the VoIP market a means to route IP traffic avoiding the technically and commercially unattractive PSTN interconnection structure.

Bridging the VoIP islands

VoIP interconnection differs fundamentally from PSTN interconnection. For voice providers in OECD countries access to a local number portability database is normal practice, and some form of an interconnection regime is imposed by regulation. Also, having an incumbent in every country, much interconnection takes place by means of standard interconnection reference offers and through transit arrangements with the incumbent. Lacking all these conditions, VoIP interconnection is basically an interconnection 'greenfield' for setting up relations between providers, but a rather complicated field. Centrally accessible VoIP databases to get routing information are absent, while setting up relations has become complex given the many new smaller and larger VoIP providers stepping in the market joining the already active traditional players. In this arena of 'VoIP islands' and 'walled gardens' the search for trusted partners to interconnect with and managing the complexity of relations has become a number one issue and the so-called 'bridging the VoIP islands' has garnered much attention.⁴⁸ In circumventing numerous

bilateral agreements negotiations, VoIP providers have turned to other interconnection models, such as setting up or joining a federation with likeminded providers, or turning to a neutral trusted partner offering peering with other providers.

Federations and VoIP peering platforms

The phenomenon of the federation, which started to take shape over the last five years, is now further maturing. The IETF WG on SIP Peering (SPEERMINT) describes a federation as “a group of Service Providers which agree to receive calls from each other via SIP on a set of administrative rules for such calls (settlement, abuse-handling, ...), and on specific rules for the technical details of the interconnection.” In general a federation is a grouping of like-minded members with similar network technology, size or business model. They exchange traffic on the basis of VoIP peering (see Box 2), but interconnection outside the federation is not necessarily based on peering. In this way the federated VoIP peering model helps its members solve the address resolution part and save on bilateral agreement costs. As VoIP peering involves a lot of technical and commercial decisions on a bilateral basis⁴⁹, the federated model offers an attractive alternative. In a broad sense groups of traditional network operators, such as the GSMA can also be considered federations. A 2006 study on “VOIP Peering & the Future of Telecom Network Interconnection”⁵⁰ examined companies providing peering services, most of them using private Carrier ENUM variants. It concluded that the federated peering model will emerge as natural trading partners come together in peering communities or federations, and it is expected that the industry will emerge in a federated peering model with ENUM directories to support the community. However, bilateral arrangements, even within federations, are expected to continue to be a prevalent method for interconnection and therefore responsible for a significant part of traffic exchange in the future.

Box 2: VoIP peering

VoIP peering as used in between federations and VoIP platforms is a concept with a broad significance. First of all it should not be confused with peer-to-peer VoIP. While it relies on IP/DNS technology, VoIP peering does not employ ‘end to end point’ routing via the lower IP transport layer. In most cases ‘controlled routing’ takes place between the switches of providers using mechanisms such as ‘next hop routing’, in a way emulating the PSTN routing model. Contrary to optimistic belief and studies carried out⁵¹ VoIP peering has up to now not ‘killed the middle man’, i.e. made the intermediate whole-sale service providers obsolete. On the other hand VoIP peering is ‘not just VoIP’ and it is ‘not just peering’. In its full implication it offers cross-platform interoperability in which any IP session from any device on any network to any device on any network is possible.⁵² The trigger application may be VoIP as VoIP peering reduces the complexity and costs of PSTN termination, settlement, and management. But due to its scalability and versatility using SIP and other protocols, VoIP peering platforms support seamless interworking of all kinds of services across domains, such as video, messaging, push to talk, gaming, etc.

Figure 7: example of a VoIP peering platform with a SIP exchange

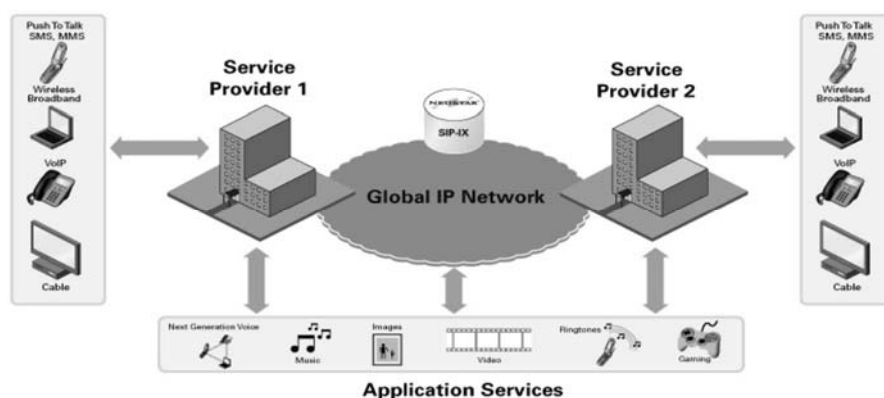

Source: Neustar.

Federations of national operators

In countries with high cable access penetration, cable operators offer an interesting test case for the VoIP federated model. Given their common network technology and controlled access networks, cable operators have an ideal position to jointly upgrade and link their networks with the latest IP/DNS technology; the strong growth of VoIP is to a large extent attributed to their new IP telephony offerings through broadband. In 2005 the Dutch cable operators joined in JCC⁵³ decided to build a SIP-exchange to support intra-carrier VoIP, and for this a central database, based on the ENUM mechanism and ‘SIP-redirect’ was needed for the conversion of telephone numbers into SIP addresses, identifying the cable operator hosting the number. The new infrastructure will enable free on-net calling between the operators, avoiding interconnection fees. The SIP exchange is crucial in the sense that the SIP URI’s also are the entrance for other future (multimedia) services associated with a subscriber, such as video calling, messaging, etc. It is expected that other countries will follow the same model as the Dutch initiative⁵⁴

Platforms for VoIP interconnection and peering

Many companies⁵⁵ have entered the VoIP peering and routing market, providing a platform for VoIP service providers. As many operators do not (yet) have enough end-to-end VoIP traffic to justify a network internal ENUM solution, they will favour utilising ENUM routing data from intermediate or hub providers. Most of these intermediate companies are neutral in the sense that they do not compete on the VoIP service level. VoIP routing and peering services are offered with varying levels of involvement. Some companies offer a pure technical platform, e.g. some IXs (Internet Exchanges⁵⁶); others deliver ‘turnkey’ VoIP services and are even running ENUM databases with subscriber data. Many companies have new VoIP providers as well as traditional voice carriers and cable operators as clients.

The GSM Association (GSMA)

Mobile operators have traditionally set up their networks, based on specialised wireless technology and closely controlled at the borders connecting with other (wireline) networks. Interconnection between mobile operators and other partners has followed the traditional PSTN voice interconnection regime. As outlined earlier the GSMA operators will roll out a new service framework called IPX. The distributed ENUM databases in IPX will eventually cover the 3 billion mobile subscribers within the reach of GSMA, thereby introducing a powerful federation with a solid net of access networks. IPX will be available for global use by any operator, mobile or fixed, wishing to connect to it.

SUMMING UP ENUM

The characteristics of the ‘ENUM rule’

ENUM is neither a stand-alone product nor a communication service; it is rather a mechanism leading to the discovery of services. There are also fundamental differences between the various deployments of the ENUM mechanism, the ‘original’ ENUM (User ENUM according to IETF RFC 3761) being just one of the many variants. To summarise the characteristics that will drive the uptake of the ENUM mechanism in the following years:

- *Versatility*: Service providers and operators are starting to embrace the ENUM mechanism, first of all to help them in the routing decision of calls between PSTN and IP environments, but in the end to support service routing in general between ‘all IP’ networks, as the ENUM domain can be used to identify various communication services like fax, mobile phone numbers, voice-mail systems, e-mail addresses, IP telephone addresses, web pages, GPS co-ordinates, call diverts or unified messaging.
- *Building block of new NGN architecture*. While used already by newcomers in the VoIP market, operators are now also considering IP-based protocols and mechanisms (DNS, SIP, ENUM) in the design and standardisation of their NGN architecture (ETSI, GSMA). The ENUM mechanism is the ‘glue’ integrating SIP URI resolution with DNS query technology and these IP-based techniques can complement signalling system SS7.⁵⁷ Some believe that such new technologies can eventually replace SS7, since this system was only designed for circuit-switched voice and data streams; it is limited to voice and SMS and cannot be used for video and multimedia. On the other hand; SS7 has a wide installed base and supports both SMS and GSM roaming, both highly profitable services for many operators, and it is not probable that SS7 will be replaced by new technologies in the near future.
- *Cost savings*: Both capital expenses and operational expenses are low compared to alternative solutions managing service and routing data. Using IP and DNS technology is relatively cheap, as the technology is widely available and easy to scale.⁵⁸ Also the costs of building and maintaining (mirror) databases is reduced as in ENUM providers and federations set up their own ENUM database, and give their partners access through fast and simple ‘DNS dips’, comparable to the underlying mechanism for searching a website or delivering an e-mail.

The suite of ENUM variants

There is no agreed nomenclature to describe all different ENUM deployments. The terminology used has varied during time and still changes depending on the forum or environment where ENUM is addressed. Figure 9 shows the basic differentiation that can be made according to two axes:

- *Public use versus private use*: Public ENUM deployments are standardised as the aim is to provide an open and globally applicable structure to insert and access ENUM data. It means that, having a telephone number as an entry, the data associated to that number can be as easily retrieved as the location of a website by browsing the public Internet. The opposite applies to private ENUM implementation, used within companies, communities, carriers or federations, all having in common a private or closed network environment. Access is limited to those inside the private environment or – when a ‘public’ domain zone is used, e.g.e164.org – restricted to authorised parties.
- *User oriented versus carrier oriented*. User orientation comes down to users in control of the communication; whether they are end users joining User ENUM or organisations or companies setting up their own ENUM databases in order to streamline their communication, triggered by the ENUM capability to control the routing of calls independently from carriers. In carrier oriented ENUM the carriers or providers agree to share subscriber information in ENUM databases. The primary function is to support routing and interconnection of calls, but in the long run also the delivery of non-voice services.

Although the same ENUM conversion principle is used in all ENUM variants, the purposes, technical architecture and administrative processes can be completely different or opposed, and therefore the different ENUM deployments should be addressed separately.

Figure 9: The suite of ENUM variants

The ENUM suite	User oriented: publicise service preferences	Carrier oriented: routing and interconnection
public ENUM	User ENUM according to RFC 3761, in the domain e164.arpa	Infrastructure ENUM standard in development (IETF) , domain to be chosen (ie164.arpa or other)
private ⁵⁹ ENUM	Private ENUM	Carrier ENUM Also mentioned; Operator ENUM, Private Infrastructure ENUM, I-ENUM
	used internally by companies, organisations and communities, usually in open domains: e164.org, e164.info, e164.televolution.net, enum.org.	used between carriers or federations of carriers, usually in restricted domains: .gprs (GSM, used for roaming), e164enum.net (GSMA, new IPX architecture)

The multiroot issue

Both public and private ENUM variants are deployed in different domains, such as e164.arpa, e164.org, e164.info, e164.televolution.net, enum.org, .gprs and e164enum.net (see Figure 9). This proliferation does not seem to lead to network conflicts or collision, and ENUM platforms using various 'roots' can apparently co-exist in the VoIP market place. It is even considered as an advantage by some market players as it allows 'multi root lookup'. This function is supported in some IP based telephone exchanges and other end user equipment (such as the Asterix platform) and enables least cost routing.

Within the Internet community, however, many have expressed concern with the introduction of TLD's which are outside the scope of the global DNS structure as co-ordinated by ICANN. A 'non-ICANN' domain such as .gprs, though used in a closed environment (GSM operators networks) could give rise to network conflicts when exposed outside its environment and also pre-empt potential applicants from proposing such a domain within ICANN.

PUBLIC POLICY ISSUES

The deployment of ENUM itself may not necessarily require new regulatory approaches, but the effects that the use of the ENUM mechanism has on certain areas, such as telephone numbering policy, number portability, standardisation, competition, privacy and security raise some questions. Analysis is helpful in order to help regulators to assess the true impact of ENUM.

Telephone numbering in NGN

New services in NGN still use telephone numbers for which they were not originally allocated. Mainly triggered by FMC (Fixed Mobile Convergence) and VoIP the significance of telephone numbering is changing drastically. Integration of mobile and fixed services, adding capabilities to voice such as

nomadic use, flattening of tariffs (*e.g.* between local area and long distance calling), all these factors lead to a change of the scope of numbers, fading the boundaries between number ranges. In this respect ECC⁶⁰ has published a report on “the future of e.164 numbering plans and allocation arrangements”⁶¹ with a set of recommendations⁶² not officially approved by ECC. Industry’s call for flexibility and broadening of the function of numbering ranges has gradually been picked up by regulators, and many regulators are adapting their numbering schemes to facilitate the market. Some examples illustrate this development: Japan is in the process of introducing a new numbering range for Fixed-Mobile Convergence (FMC) Services,⁶³ while the Netherlands widened the scope of geographical numbers by allowing nomadic use of geographical numbers outside their local area.⁶⁴ In general there is a need to use similar numbering ranges for similar services, independent of whether these services are PSTN-based or IP-based.

A closely related area, which is impacted, is number portability. Most OECD countries have number portability in place for fixed numbers and for mobile numbers, enabling end users to easily change provider. A next step following the need for flexibility of number ranges could be to consider *service* portability between numbering ranges⁶⁵. Introducing service portability between *dissimilar services* however has to be carefully examined. Most operator’s network operations and invoicing systems are based on purpose-specific numbering ranges, and consumers recognise and expect services (and related tariffs and content) on the basis of the numbering range used. Also different regulation could apply to different types of numbers.

Impact on telephone numbering policy

In general the increased use of ENUM mechanisms could accelerate developments in numbering already triggered by the uptake of IP and convergence. The telephone number is the anchor point within the ENUM mechanism and it is the entry leading to various services preferences. Thus, besides linking telephone numbers to IP telephone addresses such as SIP, which is now the main application area, the ENUM mechanism could also be used for unified messaging – like applications, diverting calls to mobile phone numbers, e-mail addresses and voice-mail systems and, as the ENUM mechanism is set up technology neutral, it could be used for services beyond the communication remit, such as linking the telephone number to web pages or GPS co-ordinates.

Number detachment

On the one hand numbers are getting more detached from their original narrow purpose, while on the other hand the importance of the number increases as an identifier for the user or subscriber rather than the service. The first effect, so called ‘number detachment’ is described in the above-mentioned ECC report as a possible major repercussion of User ENUM regarding telephone numbering.⁶⁶ While in User ENUM the detachment is more applicable to the service provider ‘attached’, in Infrastructure ENUM and Carrier ENUM the detachment from the original voice service applies, meanwhile enforcing the subscriber’s relation through the telephone number. Similar to number detachment is the still early development of the telephone number evolving into a ‘meta identifier’. Increasingly end user equipment is able to communicate through various channels and protocols, such as GSM, Bluetooth, Skype, MSN, etc. ‘Meta-client’ applications (such as Miranda⁶⁷) incorporated in these multifunctional devices could support various communication services with different identifiers, but they need one overarching meta-identifier, by which the end user’s service preferences can be traced. A natural candidate for a meta identifier is the main telephone number, and service preferences could be set up in private or public ENUM databases. Number detachment also reinforces the user’s perception of the number being ‘his number’ and his need to maintain the number regardless of the service or provider attached.

Thus, as the ENUM mechanism takes root, the linkage between telephone number and service and service provider will be under attack and the telephone number will evolve more into a personal identifier.

While it still has to be assessed which challenges these developments will pose for regulators, they will in any case increase the pressure on regulators to broaden the uses for existing numbers, to extend the possibilities of direct allocation to end users and to allow portability between PSTN-based and IP-based services. The introduction of service portability between *dissimilar services* is a more complex issue involving operator's and consumer's interests and the regulatory environment.

The life cycle of telephone numbers

A seamless transition to NGN, while keeping the huge installed base of subscribers using telephone numbers at the edges of their networks untouched, is in the interest of carriers. 'Numbering changes' have historically been costly and impacting carriers as well as end users. Provided the national telephone numbering schemes keep updated according to the changing markets needs, and the role of telecommunication regulators as neutral allocation bodies is not subject to discussion and maintained, as is now generally the case, it is expected that telephone numbers will stay key identifiers for telecommunication services for the foreseeable future, even despite the use of IP and the surge of new address schemes in NGN. The ENUM mechanism integrates telephone numbers in the new IP environment and may make them interoperable with other identifiers. As the ENUM mechanism 'anchors' telephone numbers in NGN it could even be a factor for expanding the lifespan of the E164 telephone numbering scheme.

Management of ENUM resources

The primary sources for ENUM are telephone numbers, in most OECD countries regarded as national resources and allocated by telecommunication regulators according to telecommunication regulations. With ENUM mechanisms telephone numbers are mapped to unique images which have the format of domain names and the resulting ENUM domain name space is split in national branches following the international dialling codes for countries (such as +33 for France). In this respect there is a similarity with the ccTLD space (Country Codes Top Level Domains) containing separate domain names zones defining a country or territory (such as .fr for France).

The similarity with ccTLD zones has influenced the management models of User ENUM, and the same private self-regulatory or public-private co-operation models as can be seen in the management of ccTLDs are implemented in User ENUM. As outlined earlier, there is often some form of regulatory control or light oversight, which can be triggered by the need to guarantee the right of sovereignty over the national User ENUM zone.⁶⁸ The regulatory involvement cannot always be assured by national telecommunication regulation since Internet resources do not always come within the remit of national bodies, but in the case of User ENUM the instructions between ITU and IAB could provide a means to impose conditions safeguarding national sovereignty or other public interests, such as the continuity of the User ENUM function for citizens. Private sector leadership in the management of domain names has been recognised broadly and self regulation has proved beneficial for the expansion and stability of the Internet, and in general for most OECD countries there is no reason why it should not relate also to ENUM.

Number Portability

The use of the ENUM mechanism leads to the creation of many private ENUM databases in the control layer of networks, providing the combination "telephone number – hosting provider". These lists, although used in a private setting, are essentially fulfilling the same function for VoIP as the LNP databases (Local Number Portability) have for the PSTN wireline and wireless voice. They support the lookup function for providers in order to route VoIP calls to their proper destination at another network. Local Number Portability databases do not provide a viable alternative (yet), as these databases do not manage alternative addresses besides telephone numbers. Most currently deployed LNP databases are also

not designed or equipped to integrate IP/DNS based queries. The ENUM mechanism in combination with DNS database technology associating data with numbers, such as call routing preferences and tariffs, is therefore the natural candidate for next generation number portability platforms. Standardisation bodies are beginning to take up the subject,⁶⁹ and within industry solutions are being proposed to upgrade the number portability service models.

As outlined in earlier, the new GSMA IPX service model is planning to roll out the private ENUM domain *e164enum.net* and the corresponding ENUM databases linked to the domain will eventually cover their 3 billion mobile subscribers, containing the call termination preferences related to their telephone numbers. As outlined by the chair and other members of the ENUM Ad hoc Group⁷⁰ the GSMA recognises that "ENUM Number administration is an area of significant interest and concern". The Carrier ENUM platform will be built into the new GSMA IPX service framework for use by "On-Net" operators, and within the GSMA there are interesting but still preliminary ideas about adapting national NP regimes to interwork with IPX.

Next Generation Number Portability platforms

Today approximately 40 countries/jurisdictions operate number portability and the majority of these countries have either central organisations that operate a number portability (NP) database, or support NP through a "distributed NP model" without a central organisation. Many carriers are of the view that these existing number portability databases should be kept as they represent a huge investment. With an "ENUM Database" added in each country following the national E.164 topology, the existing number portability database could be upgraded with an ENUM query interface. The question of course remains who should run these added databases, and how this will affect competition. In this context it is important to realise that the ENUM mechanism and IP/DNS technology allow for sophisticated and distributed data management. The separation of 'Tier 1' and 'Tier 2' functions, while maintaining low cost and fast queries, allows different business models, as illustrated by Figure 10.

Figure 10: National options adding ENUM Number Portability queries

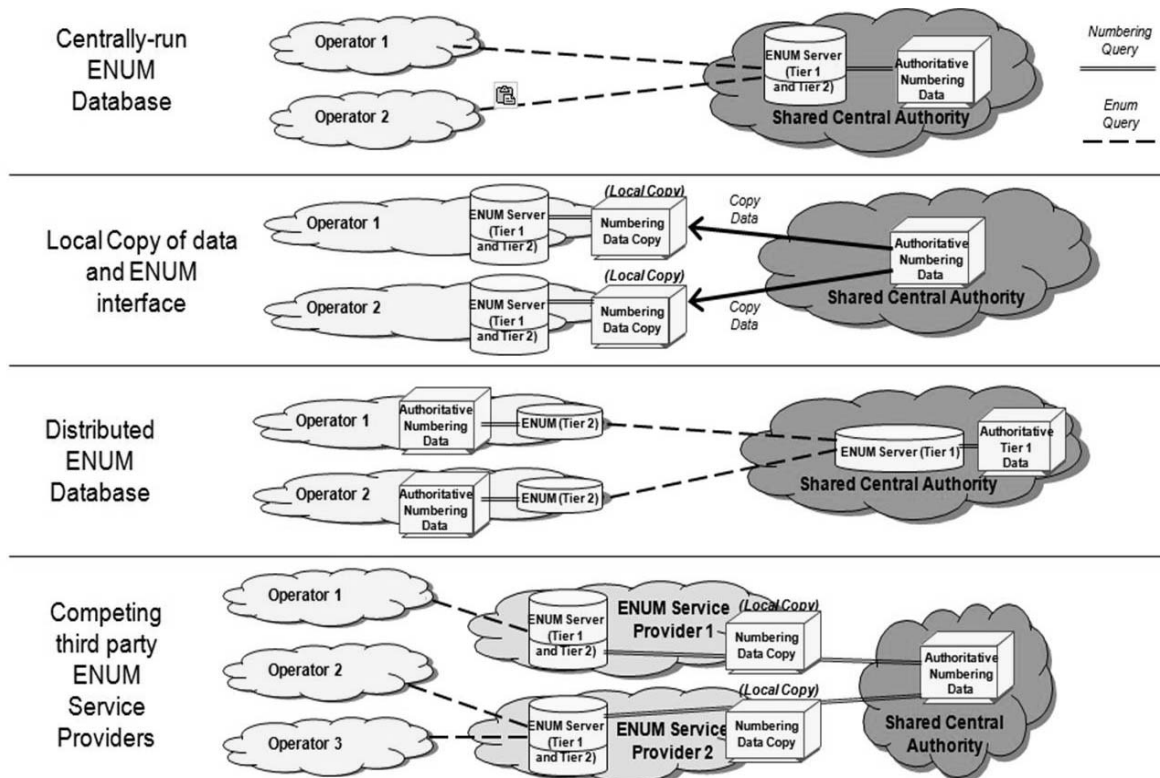

Source: GSMA

The way national NP models should be adapted or next generation platforms should be built depends very much on the way NP is regulated and organised locally, and the position of the national telecommunication authority is therefore an influencing factor. The main regulatory question is therefore the extent to which national regulatory authorities should be involved.

In an environment where no real initiatives have yet materialised industry players have different ideas about the setup of next generation platforms.⁷¹ On the one hand there is the view that these platforms should be centralised, just as is the case now in certain countries. The regulatory authority should impose a single national numbering registry, thereby ensuring that all URI data would automatically be corrected for number portability, and the access to these data would be safeguarded by all market parties, both traditional carriers as well as VoIP ‘newcomers’. The path to follow would be to set up a competition neutral ‘single registry’ (first model in Figure 10) with possibly distributed Tier-2 functions (third model in Figure 10).

On the other hand there are industry players and regulators who prefer to rely on market forces, and allowing competition between (multiple) ENUM registries is an important factor for the evolution of the interconnection market. An open choice for the provisioning registrar and the query model should be guaranteed. Following these views the market could evolve along the lines of the second and fourth model in Figure 10.

In all cases, as most ENUM databases will probably be segmented on a national basis according to the E164 numbering plan, such as the distributed Carrier ENUM databases to be set up by the GSMA operators, it becomes a matter of national scope and attention.

Setting the standard for Infrastructure ENUM

The setting and propagation of Internet standards have allowed for a stable Internet evolution and ENUM is no exception. As outlined above and further two types of standardisation efforts are taking place. On the one hand the ENUM conversion mechanism, enriched by a set of IETF documents, is being embedded in NGN network standards, while on the other hand the IETF is proposing Infrastructure ENUM, aimed at dedicating a unique domain for carrier routing data. The last effort, to be conducted in co-operation with the ITU, touches upon the areas of interoperability and competition.

The efforts to determine a *unique* domain for Infrastructure ENUM raises questions, as already various private Carrier ENUM deployments exist. An important aspect when assessing the need for a global standard seems to be the trade-off between compliance and diversity. The downside of diversity is that it can lead to non-interoperable services and in its extreme form to bad niches offering harmful goods. From a general economic perspective there is a necessity to set standards ‘at the right time, so as not to harm development and innovation, neither allowing the distribution and domination of inferior products’.⁷² As can be seen now a diversity of ENUM services has emerged and the VoIP – market – the main user of Carrier ENUM – shows a meshed pattern of competing carriers and service providers, increasing service offerings and lower prices. Interoperability is mainly tackled on an *ad hoc* basis between carriers and providers, but shared protocols are used and the lack of a global standard is apparently not hindering the market or leading to market failures. The multitude of ENUM applications do also ensure technical diversity, as up to now no ENUM ‘mono-culture’ can be seen, meaning a situation in which one service provider or federation has the *de facto* monopoly on the basis of a proprietary protocol, avoiding also the risk of introducing a "single point of failure".

As outlined in Box 1, carriers have fundamental objections to the deployment of a *publicly accessible* ENUM database, and this raises the question whether the major stakeholders, the carriers themselves, will adopt Infrastructure ENUM in the long run. Other than User ENUM, where the focus is on ‘personal reachability’, massive deployment is a *sine qua non* condition for Infrastructure, where the main goal is interoperability.

There are, however, carriers and regulators who see benefit in the deployment of Infrastructure ENUM, as it provides the overarching domain by which the E.164 numbers can unambiguously be mapped to addresses for use within IP-based networks for further routing. One of the arguments heard is that using different domains in parallel containing different routing data for the same number can lead to conflicts compromising the service provision by providers and even the integrity of the telephone numbering scheme. However, most domains are used privately and within federations, thus minimising these kinds of risks and providers can cope with the complexity of using different domains. In this context the Infrastructure ENUM domain could even evolve as a ‘meta domain’, pointing to the databases of private domains, provided they have an interest and open up as publicly accessible domains.

Just as in User ENUM, the Infrastructure ENUM branches will be set up following the borders of national telephone numbering plans, and regulators will have to decide whether the sovereignty over telephone numbers will apply equally on these ENUM branches. In the end the deployment of Infrastructure ENUM is a voluntary and national decision, and could provide benefits on a national scale for routing and setting up ‘next generation’ number portability systems. In this context there are regulators already expressing interest in co-operating with industry to set up ENUM databases according to the public Infrastructure ENUM standard.⁷³

Competition considerations

The voice market, specifically the market of termination of telephone calls on fixed and mobile networks, is regulated in most OECD countries due to dominant market positions. By making interconnection mandatory, and setting the prices at which operators have to allow interconnection to their networks, the right conditions are set for fair play in order to introduce competition. The ultimate aim for regulators is to withdraw from this market, once competitive conditions have been achieved, and the general expectation is that this goal will be reached when interconnection follows the Internet model. As an alternative to the ‘mandated access’ regime, general competition law would then provide for sufficient protection against anti-competitive behaviour.

In the traditional voice market, carriers are interconnected directly or indirectly through transit arrangements with major carriers, such as the incumbent. Transit arrangements simplify interconnection for smaller players and enlarge the scope of the number of other networks that can be reached. As the incumbent is often the dominant market player for both interconnection and transit, asymmetrical regulation imposed on the incumbent offers a way to very closely watch anti-competitive behaviour in this pivotal point of interconnection and intervene if necessary.

ENUM is an important mechanism in the core of new IP-based interconnection models, and especially the federated model and further, facilitates interconnection arrangements between participating service providers, offering an alternative to the many bilateral arrangements needed in the meshed environment in which many old voice providers and new VoIP providers operate. However, it introduces competition risks. Federations managing access networks with large numbers of subscribers, such as cable operators’ associations or the GSMA, could become significant market powers on the VoIP market. These ‘walled gardens’ could hinder access, or at least impose unilaterally the conditions for VoIP access to their subscribers. Analysing which *ex post* or *ex ante* regulatory instruments are available, inside or outside telecommunication regulation, falls outside the scope of this paper. However, requiring access to ENUM databases is a powerful tool regulators could consider as ENUM data are the primary source needed to set up interconnection. In general, interoperability in the VoIP market could benefit from transparent and non-discriminatory conditions for access to ENUM data, just as is the case with number portability data in most OECD countries.

Privacy and the protection of personal data

The privacy concerns raised by ENUM have mainly focused on User ENUM, which may permit the public retrieval of personally identifiable information, such as e-mail addresses and SIP addresses. At the end of the 1990s, when User ENUM was presented, the perception was that the standard RFC 3761 merely dealt with ENUM in a technical way, without sufficient regard to the policy dimensions of the registration process. Although the IETF did react and issued a document providing insight into privacy and security,⁷⁴ the fear was that User ENUM provided in the context of a self-regulatory framework would not have sufficient safeguards for privacy. Academic papers⁷⁵ as well as studies carried out for regulators⁷⁶ urged for caution when implementing User ENUM.

Many parties have expressed the fear that marketers, spammers, and malicious actors will mine User ENUM for personal contact information. However, there are limitations to the way in which personal data can be retrieved.⁷⁷ In practically all current User ENUM deployments an opt-in regime is required and corresponding privacy policy is set in place,⁷⁸ it is the user who eventually actively decides which data he wants to publish in a public way. Furthermore the telephone number for a user needs to be known and inserted in User ENUM in order to retrieve associated data, and User ENUM will subsequently reveal that a certain number is in use with certain services and give the resources needed to use these services. Backwards retrieval mechanisms are not supported and User ENUM databases cannot be massively mined

as queries take place on an individual basis. In addition, some registries can restrict certain types of queries in advance or when a certain massive pattern is detected. Furthermore the user could add access restrictions to the service behind a resource given by User ENUM.⁷⁹ One of the most feared risks, the explosion of Spam over VoIP (SPIT or SPIM), is a problem inherent to VoIP services. While ENUM could aggravate SPIT/SPIM, it is basically a problem to be tackled at the VoIP service level rather than on the ENUM level.

Security

The security risks associated with public deployments of ENUM, such as User ENUM and the future Infrastructure ENUM are of a different and greater magnitude than those of private ENUM deployments. Public ENUM implementations rely on public DNS resolution mechanisms, a feature not present in private ENUM deployments not connected to the Internet. The risks that networks and services connected to the Internet are facing are analysed by the IETF in a general document "Threat Analysis of the Domain Name System".⁸⁰ Most of these risks apply for public ENUM implementations because (quote RFC 3761); "ENUM uses DNS, which in its current form is an insecure protocol, and there is no mechanism ensuring the data one gets back is authentic. As ENUM is deployed on the global Internet, it is expected to be a popular target for various kinds of attacks, and attacking the underlying DNS infrastructure is one way of attacking the ENUM service itself". The main threats public ENUM databases services are exposed to, which therefore indirectly affect the services using ENUM, are mentioned in RFC 3761:

- *Packet Interception:* 'Monkey-in-the-middle' attacks, eavesdropping on requests combined with spoofed responses that beat the real response back to the resolver.
- *ID Guessing and Query Prediction.* This allows an attacker to masquerade as a trusted server and could lead to identity theft. This attack is similar to a packet interception attack.
- *Name-based Attacks:* Name-based attacks use the actual DNS caching behaviour as a tool to insert bad data into a victim's cache, thus potentially subverting subsequent decisions based on DNS names.
- *Betrayal By A Trusted Server:* Another variation on the packet interception attack is the trusted server that turns out not to be so trustworthy, whether by accident or by intent.
- *Denial of Service (DoS).* As with any network service DNS is vulnerable to denial of service attacks. DNS servers are also at risk of being used as denial of service amplifiers,
- *Authenticated Denial of Domain Names:* Regarded as a specific problem within ENUM; erroneous or even some missing data in ENUM databases can change the call routing policy associated.

Authentication is probably the most important security issue within public ENUM deployments; most of the above-mentioned threats, except Denial of Service attacks, are related to authentication. ENUM servers should be configured as to only act and respond to authorised queries. Part of this can be solved by verifying the authenticity of the data via DNSSEC.⁸¹ Additionally extra authentication mechanisms will be needed as part of the setup process for the services themselves using the ENUM mechanism. Denial of Service attacks are a specific problem, and the fear of disrupting public ENUM is real. Public ENUM databases however, are comparable to other publicly accessible network elements, such as name servers,⁸² and can be set up in the same way offering robustness by distribution, replication and redundancy. In this context it is important to realise that it is not the communication services using ENUM that are the prey of a DoS attack but the ENUM servers.

In general ENUM does not introduce risks to users and networks which are not known already in Internet's recent history, but the difference is that these risks indirectly affect communication services

using ENUM. This is the reason that carriers are mostly concerned that a public Infrastructure ENUM could compromise the reliability and integrity of the real time voice communication used by their subscribers and disrupt their business. For many carriers and operators (such as the GSMA with the new IPX service model) it constitutes a major argument not to use public ENUM variants.

GLOSSARY

3GPP	3rd Generation Partnership Project
3GPP2	3rd Generation Partnership Project 2
API	Application Program(ming) Interface
CAPEX	CApitale Expenditure
ccTLD	Country code Top Level Domain
CEPT	European Conference of Postal and Telecommunications Administrations
DDoS	Distributed Denial of Service Attack
DNS	Domain Name System
DNSSEC	Domain Name System Security Extensions
DoS	Denial of Service Attack
E.164	ITU-T recommendation E.164, defining the international public telecommunication numbering plan
ECC	Electronic Communications Committee within CEPT
ETSI	European Telecommunication Standardisation Institute
FMC	Fixed-Mobile convergence
GPS	Global Positioning System
GSMA	GSM Association (Global System for Mobile communications)
IAB	Internet Architecture Board (IETF)
ICANN	Internet Corporation for Assigned Names and Numbers
IESG	Internet Engineering Steering Group (IETF)
IETF	Internet Engineering Task Force
IM	Instant Messaging
IMS	IP Multimedia Subsystem
IPv4 or IPv6	Internet protocol version 4 or 6
IPX	IP Interworking eXchange
ISP	Internet Service Provider
ITU	International Telecommunication Union
LNP	Local Number Portability
MMS	Multimedia Messaging Service
NAPTR	Naming Authority Pointer Records
NGN	Next Generation Networks
NP	Number Portability
OPEX	Operational Expenditure
P2PSIP	Peer to peer SIP
PSTN	Public Switched Telephone Network
QoS	Quality of Service

RFC	Request For Comment (IETF)
RFC 3761	The IETF protocol defining "User ENUM"
RIPE/NCC	<i>Réseaux IP Européens</i> /Network Coordination Centre
RR	Resource Records
SIP	Session Initiation Protocol (IETF)
SPEERMINT	Session PEERing for Multimedia INTerconnect (IETF)
SPIT	SPam over Internet Telephony
SS7	Signaling System #7
TCP/IP	Transmission Control Protocol/Internet Protocol (protocol suite)
TISPAN	Telecommunication and Internet Converged Services and Protocols for Advanced Networks
URI	Uniform Resource Identifier
Whois	TCP-based query/response protocol used for querying a DNS database

NOTES

N.B. All hyperlinks were accessed November 2008, unless stated otherwise

- ¹ DSTI/ICCP/CISP(2007)2/FINAL
- ² Subscribers of mobile communication services are identified by an IMSI (International Mobile Subscriber Identity) characterised by a country code, a network code and a subscriber number, according to the ITU E.212 numbering standard.
- ³ OECD Foresight Forum "Next Generation Networks: Evolution and policy considerations", held in Budapest, 3 October 2006 (<http://www.oecd.org/dataoecd/24/5/38079155.pdf>).
- ⁴ Mr. Schink, VP Network Technology Strategy, Siemens and Vice-chair of ITU-T Study Group 13.
- ⁵ Mr. Mueller, head of Regulation & Competition Law, BT, OECD Foresight Forum, op. cit.
- ⁶ Mr. Stastny, Senior Analyst, OeFEG, Telekom Austria, OECD Foresight Forum, op. cit.
- ⁷ In the following years IP networks will have to adapt to the successor of IPv4; IPv6. The expectation is that IPv4 addressing will long coexist with the new IPv6 addresses.
- ⁸ The TCP/IP protocol suite is named after two of the most important protocols used in the Internet: the Transmission Control Protocol (TCP) and the Internet Protocol (IP).
- ⁹ Because of the use of NAT (Network Address Translation) and dynamic IP address allocation
- ¹⁰ SIP (Session Initiated Protocol) is a signalling protocol defined by the IETF to locate users and establish interactive communications with them. It is similar to setting up a call on the telephone network, with two crucial differences:
- i)* It is internet native, giving the versatility to interoperate with other protocols used in the IP environment.
- ii)* It separates 'session establishment' from 'session description', so specifying who or what you would like to connect to, is independent of how you would like to communicate.
- SIP is considered the glue for a variety of applications beyond VoIP, for which it is now widely used, such as multimedia, mobility, IM and presence, e-commerce and web services.
- ¹¹ While these schemes often use the e-mail address or a self-chosen ID as an entrance for users, the underlying numbering schemes are self chosen and proprietary.
- ¹² "Regulatory implications of the introduction of next generation networks and other new developments in electronic communications", 2003, study from Cullen/Devoteam Siticom for the European Commission.
- ¹³ This means the ENUM mechanism in general.

14 Cullen 2003; 3..1.4. Interworking of addressing systems; The convergence towards NGNs requires the interworking of the different naming, addressing and numbering systems. This includes the traditional public telephony E.164 numbers, Internet names (e-mail addresses or website addresses), IP addresses and Instant Messaging identifiers. Several solutions are being proposed for the mapping and interworking of these names and addresses.

The ENUM (tElephone NUmber Mapping) specified by the IETF provides a mapping between public telephony numbers and other resources.

The implementation of ENUM raises a number of issues, including the role that the different market players will have to play in the implementation and the maintenance of the system, as it could lead to the emergence of control points in the system.

15 Definition: VoIP, also known as Internet telephony or IP Telephony, is the routing of voice conversations over the Internet or any other IP-based network thus enabling people to talk, just as they would over a standard phone call, via computers or electronic devices that support the technology.

16 The origin of the word ENUM remains unclear. Both 'tElephone NUmber Mapping' or 'Electronic NUmber Mapping' are found in literature sources, but it is also suggested it is not even an acronym.

17 The Internet Engineering Task Force (IETF) is one of the leading standardisation bodies of the (core technologies of the) Internet. It is formed by a large open international community of network designers, operators, vendors, and researchers concerned with the evolution of the Internet architecture and the smooth operation of the Internet. IETF produces RFC documents.

18 The Requests for Comments (RFC) document series is a set of technical and organisational notes about the Internet. While few RFCs are official standards, almost all Internet standards used are recorded in RFCs and can be regarded as *de facto* standards.

19 RFC2916, the first standard developed became obsolete when redrafted into RFC3761.

20 More specifically RFC3761 states: "Through transformation of International Public Telecommunication numbers in the international format, called within this document E.164 numbers, into DNS names and the use of existing DNS services like delegation through NS records and NAPTR records, one can look up what services are available for a specific E.164 in a decentralized way with distributed management of the different levels in the lookup process."

21 Presentation by Richard Shockey, IETF ENUM WG Co-Chair at an ISOC seminar 11 October 2007 on Infrastructure ENUM: <http://isoc.nl/activ/2007-SIP SIG-infrastructureENUM.htm>

22 According to RFC3761: "The same mechanisms might be used for private dialling plans. If these mechanisms are re-used, the suffix used for the private dialling plan MUST NOT be e164.arpa, to avoid conflict with this specification. Parties to the private dialling plan will need to know the suffix used by their private dialling plan for correct operation of these mechanisms. Further, the application unique string used SHOULD be the full number as specified, but without the leading '+', and such private use MUST NOT be called "ENUM."

23 The majority of dialling codes according to E.164 refer to single countries, the significant exception being the region of North America with its integrated numbering plan under +1. In generic terms therefore, referrals in this document will be made to 'country codes' and 'national implementations'.

24 The delegation process and the mentioned instructions can be found on the websites of RIPE (www.ripe.net/rs/enum/index.html) and ITU (www.itu.int/ITU-T/inr/enum/) providing also more in-depth information on ENUM and ENUM delegations.

- 25 Figures according to <http://crawler.enum.at/>. This DNS-based crawler crawls through e164.arpa, the top level domain designated for ENUM. Specifically, it looks for NAPTR resource records sets, and tries to discover the whole "golden" ENUM tree. Last accessed on 16 February 2009.
- 26 The Domain Name System DNS serves as the "phone book" for the Internet by associating human-readable computer hostnames (*e.g.* oecd.org) to IP addresses, that networking equipment needs for delivering information or services. Delegation of domain name zones (*e.g.* .org or e164.arpa) take place following procedures from IANA (see www.iana.org) and ICANN (www.icann.org).
- 27 As mentioned by Patrik Fältström, co-chair of the IETF ENUM WG, many examples apply for very slow progress in adoption of protocols; DNSSEC, source address filters, md5 checksum on bgp, anti-spam solutions like digital signatures on e-mail, IPv6, and MIME. It took MIME 15 years to get world wide acceptance as the email protocol.
- 28 *E.g.* telegraphy, telephony, TCP/IP, World Wide Web.
- 29 Press release Infonetics, August 2007 announcing the new study "Service Provider Plans for Next Gen Voice & IMS," (www.infonetics.com/).
- 30 ISOC, Column on Infrastructure ENUM, by Geoff Huston, March 2007, <http://ispcolumn.isoc.org/2007-03/infra-enum.html>.
- 31 Von Europe Spring 2007; David Bryan: "P2P SIP will do to VoIP what VoIP has done to the PSTN" Moore's law on the growth of computing power, Metcalfe's law on the value of the network being the square of the number of its endpoints and the rise of the dumb network - the Internet have all made peer-to-peer (P2P) computing inevitable. P2P traffic has already been dominant on the Internet for some time. P2P Internet communications are thus a natural evolution. Various pre-standard P2P systems such as the world's leading VoIP Skype service as well as P2P PBXs are already on the market. True global communications can however only be based on standards. P2P SIP standards work has emerged as probably the hottest topic in the IETF where Internet standards are developed."
- 32 Four documents on Infrastructure ENUM were submitted to the IESG. The Internet Engineering Steering Group is a body composed of the IETF Chair and its Area Directors. Three of these documents are mentioned in the following three footnotes, the fourth is the following: The document "ENUM Branch Location Record" defines the ENUM Branch Location record (EBL) which is used to indicate where the ENUM tree for special ENUM application is located. (<http://tools.ietf.org/html/draft-ietf-enum-branch-location-record-03>)
- 33 This is described in an informational RFC 5067, called "Infrastructure ENUM Requirements", providing requirements for "infrastructure" or "carrier" ENUM (E.164 Number Mapping), defined as the use of RFC 3761 technology to facilitate interconnection of networks for E.164 number addressed services, in particular but not restricted to VoIP (Voice over IP.) For the latest version of this document last, see (www.ietf.org/rfc/rfc5067.txt).
- 34 Another memo of the IETF ENUM WG proposes an interim solution to allow a combined User and Infrastructure ENUM implementation in e164.arpa as a national choice until the long-term solution is approved. This interim solution should be deprecated after approval of the long-term solution, see www.ietf.org/internet-drafts/draft-ietf-enum-combined-08.txt
- 35 Public DNS servers generally show low latency rates, but high latency can occur outside the control of the operators own network. High latency results in long transaction times and users waiting for responses. Operators require faster response times to querying elements, or else subscribers may migrate to a competitive service, resulting in lost revenue.

36 Correct routing selection varies depending on the business model of the carrier originating the call and when more than one valid termination option exist, least-cost-routing is required. Within IETF though there are developments in order to enable such differentiated service-specific routing in global ENUM variants.

37 In an ITU-IETF NGN Workshop Geneva, May 2005, Jon Peterson brought forward the idea that voice communication should basically be just an application on the Internet. Seen in the context of the Internet as a network without central intelligence (the stupid network) based on the end-to-end principle, it leads to a series of conclusions:

- Every user may reach any other user via the IP address.
- All “services” may be offered anywhere and may be accessed from everywhere.
- This is of course also valid for voice and other communication “services”.
- Voice and other communications do not need a “service” provider at all, they are applications.

38 See ETSI/TISPAN website at: http://portal.etsi.org/portal_common/home.asp?tbkey1=TISPAN.

39 See ITU-T Next Generation Network Global Standards Initiative (NGN-GSI), online at www.itu.int/ITU-T/ngn/index.phtml.

40 Internet Engineering Task Force, online at www.ietf.org.

41 See 3GPP and 3GPP2 web pages, respectively at: www.3gpp.org/ and www.3gpp2.org. Partners include several private sector organisations such as the European ETSI, the US-based ATIS, the Japanese ARIB, the Korean TTC, and the Chinese CCSA.

42 Founded in 1987, GSMA is a global trade association representing over 700 GSM mobile phone operators across 218 countries. In addition, more than 200 manufacturers and suppliers support the Association’s initiatives as associate members (www.gsmworld.com).

43 Telecommunications and Internet Converged Services and protocols for Advanced Networking (TISPAN).

44 September 2007, Draft ETSI TR 184 007 V<0.0.7> (2007-09) Naming/Numbering Address Resolution (NAR); RTS/TISPAN-04011-NGN. This Technical Report (TR) was produced by ETSI Technical Committee TISPAN Working Group 4 with responsibilities covering naming, numbering and addressing for electronic communications networks.

45 ETSI TR 102 055 V1.1.1 (2005-05) Technical Report TISPAN; ENUM scenarios for user and infrastructure ENUM.

46 GSM Association Official Document PRD IR.67 "DNS Guidelines for Operators", (www.gsmworld.com/documents/ireg/ir6730.pdf).

47 Multimedia Messaging Service (MMS) is a standard for telephony messaging systems that allows sending messages that include multimedia objects (images, audio, video, rich text) and not just text as in Short Message Service (SMS).

48 The Jeff Pulver Blog, notes, comments and observations, 3 May, 2007: “The time has come for VoIP Islands to have bridges. In other words, the level of interoperability and the amount of subscribers / minutes associated with VoIP technology is significant enough that direct interconnection is happening. Using a variety of techniques companies are providing interconnection and enabling end to end VoIP solutions. VoIP peering will continue to happen between carriers, but the business models driving peering will not be worked out until 2007 or beyond.” (<http://pulverblog.pulver.com/archives/006910.html>)

49 According to Steve Heap, CTO of Arbinet, VoIP peering is ‘hard work’ (ISOC seminar 11 October 2007, on Infrastructure ENUM, <http://isoc.nl/activ/20071011-SteveHeap.ppt> :
- Identify all peering partners.

- Agree upon a commercial relationship.
- Agree upon IP addresses to interconnect.
- Agree upon private or public Internet transport.
- Exchange and update numbers with all your partners.
- Query all outgoing calls against an ENUM-like server.
- Bill and settle for termination, when required.

50 Press release and executive summary of Heavy Reading's study on 'VOIP Peering & the Future of Telecom Network Interconnection' August 2006.

51 Press release and executive summary of Heavy Reading's study on 'VOIP Peering & the Future of Telecom Network Interconnection' August 2006.

52 Presentation by Richard Shockey, IETF ENUM WG Co-Chair at an ISOC seminar 11 October on Infrastructure ENUM <http://isoc.nl/activ/2007-SIP SIG-infrastructureENUM.htm>.

53 JCC is a Dutch joint cable initiative involving 5 cable operators (UPC, Essent, Casema, Multikabel, CAIW) covering 6 million households, app. 90% of all households in the Netherlands.

54 CableLabs started a project "CableLabs Voice over IP (VoIP) Peering Project" and issued a Request for Information (RFI) in November 2005 to provide assistance in defining the technical scope, requirements and architecture for VoIP Peering between cable operators. The reference 'high level architecture' requires an ENUM query interface linked to the managed IP backbone of the cable operators, for service preferences and location of subscribers (www.cablelabs.com/downloads/CableLabs_VoIP_Peering_RFI.pdf).

CableLabs (Cable Television Laboratories, Inc.) is a consortium dedicated to pursuing new cable telecommunications technologies and helping its USA based cable operator members integrate those technical advancements into their business objectives.

55 Not meant as an exhaustive listing, the following companies are frequently mentioned in the VoIP peering market place: Arbinet, E164.info, Netnumber, NeuStar, nexVortex, Stealth Communications, Telcordia, Verisign, VoEX, Inc, X-Connect.

56 *e.g.* the AMS-X (Amsterdam Internet eXchange)

57 Signaling System #7 (SS7) is a set of telephony signalling protocols which are used to set up the vast majority of the world's PSTN (public switched telephone network) telephone calls. The main purpose is to set up and cancel telephone calls.

58 Hwang, J., & Mueller, M. (2003). "Economics of New Numbering Systems Over Cable Broadband Access Networks: ENUM Service Model." (<http://citeseer.ist.psu.edu/570469.html>).

59 In private ENUM implementations the border between user orientation and carrier orientation can be diffuse, *e.g.* a large international company could set up private ENUM both for call routing and the support of 'multimedia' services for its employees.

60 The ECC is the Electronic Communications Committee within CEPT, the European Conference of Postal and Telecommunications Administrations. Presently 48 countries are members of CEPT, (www.cept.org/)

61 "The Future of E 164 Numbering Plans and allocation Arrangements," ECC Report 87, Lisbon, September 2006, (<http://www.ero.dk/documentation/docs/doc98/official/pdf/ECCREP087.PDF>).

62 Only the most relevant recommendations in the context of numbering policy and the ENUM report are given:

Recommendation 2: NRAs should introduce new number ranges for new services only when really needed and only if it is quite inappropriate to accommodate the new services in existing ranges. Subscribers should be allowed to retain their existing numbers for enhancements to existing services and new services that retain compatibility with existing services. The scopes of services allowed for the number ranges concerned should be correspondingly widened.

Recommendation 3: NRAs should study further the implications of removing the geographic significance of numbers within their own country, especially for interconnection and should consider taking this step when the operators start to adopt IP-technology widely.

Recommendation 4: NRAs should recognise that nomadicity is a user benefit and should not apply usage conditions that restrict the user benefit of nomadicity. Such restrictions would not be enforceable in practice anyway. In the longer term, NRAs and ECC NNA should consider proposing revisions to E.164 if the use of cross border nomadicity grows substantially.

Recommendation 8: NRAs should consider updating and broadening number portability requirements between operators of dissimilar services in accordance with the broadening of the scope of number ranges in the numbering plan.

Recommendation 12: There does not appear to be a great deal to gain from moving to a system of individual number allocation although there is a gradual trend for the rights of users over numbers to increase. Developments around "user" ENUM should however be monitored as they could lead to the need to move to personal allocation.

Recommendation 13: NRAs could consider exploring the advantages and disadvantages of allowing numbers to be made available to users with or without a link to the country concerned and who are not resident in that country or area to have a virtual presence there, subject to reasonable measures including the need to ensure that adequate numbers remain available for residents and that numbers do not have to be lengthened to meet demand.

63 September 2007, proposal to amend the 'Regulations for Telecommunications Numbers (MPT Ordinance No. 82 of 1997)' in order to facilitate a new numbering range for Fixed-Mobile Convergence (FMC) Services, www.soumu.go.jp/joho_tsusin/eng/Releases/Telecommunications/news070920_5.html

64 July 2006, change of the Numbering Plan allowing nomadic use of geographical numbers outside the local area and even the country borders, provided the subscriber's main residence is in the local area the numbers belong to. In parallel two new numbering ranges were introduced for Internet services, such as non geographic VoIP and video calling. (www.ez.nl/content.jsp?objectid=145031&rid=145066).

65 Recommendation 8: op. cit.

66 "The significance of user ENUM in particular is that numbers that were allocated for use with a given operator will start to be used also for services that are provided by another operator or are self provided; this may even happen when the number is stored in a ENUM database for the first time if the Tier 2 provider is different from the telephone service provider. At some stage the user may wish to discontinue the original service but keep the number to continue it newer use. Thus numbers may gradually become detached from the service providers that they were originally associated with and be associated with different or multiple service providers. We call this effect and the pressure for it number detachment".

67 Miranda Instant Messenger is a minimalist, open source multiprotocol instant messaging application, designed for Microsoft Windows. Miranda is free software distributed under GNU General Public Licence.

68 Preserving the sovereignty over a national resource is a concern of many regulators. An example is given by the principles the Department of Commerce of the USA issued to guide domestic implementation of (User) ENUM; “Any participation by the United States in a coordinated, global approach must preserve the United States' national sovereignty. That is, the United States and every other participating nation should have the right to determine whether and in what manner ENUM or any alternative is implemented domestically.”

69 ETSI/TISPAN released a Draft ETSI TR 184 003 V0.1.1 (2007-09) mentioning:

“7. Portability in a post-E.164 environment

E.164 numbers will continue to be required for the foreseeable future (specifically until the last legacy networks and CPE that can only handle numbers have been removed from service). Nonetheless we must expect to see the growth (in parallel with E.164 numbers) of SIP URIs at the UNI. At present the market for such identifiers in a public network environment is not mature and thinking about their use is not well developed. However it should be noted that there are 2 types of SIP URI, using the formats:

- sip:user@supplier (eg. sip:quin.collier@example1tel.com)
- sip:user@userdomain (eg. sip:quin.collier@sadoldgit.co.uk).

In the former case portability as we currently understand it appears impossible as the identity of the supplier is an intrinsic part of the name, whereas in the latter case it should be possible subject to the existence of suitable network functionality.”

70 Marcus Evans ENUM Forum, Berlin, 15 June 2007.
PT 2 TRIS Copenhagen Meeting, 22-23 March 2007.

71 The study “Infrastructure ENUM, Implementation options for the Netherlands” from November 2006, concluded that there is no alternative seriously to be considered other than Infrastructure (Carrier) ENUM for enabling VoIP interconnection and facilitating number portability in the Netherlands. While facilitators, vendors and interest groups clearly support an open model for number portability through public ENUM implementations, it is most likely that closed models (private ENUM established by operators and federations) operators will arise, on the long run merging with other models.
(<http://isoc.nl/files/ScriptieLennartMaris.pdf>)

72 Zixiang (2002) “Testing Theory of Bandwagon – Global Standardization Competition in Mobile Communications”, *International Journal of Information Technology & Decision Making*, Vol 1, No 4, p. 615

73 Within ACMA, the Australian ENUM Discussion Group (AEDG) set up an Infrastructure ENUM Sub-working Group in April 2007, to investigate and report on:

- existing implementations of Infrastructure ENUM and the different models that have been used.
- The extent to which Infrastructure ENUM has undergone standardisation within the Internet Engineering Task Force and other standardisation bodies.
- Current research activities into Infrastructure ENUM.
- Whether an Australian implementation of Infrastructure ENUM is feasible.

See [/www.acma.gov.au/WEB/STANDARD/pc=PC_2475](http://www.acma.gov.au/WEB/STANDARD/pc=PC_2475).

74 See: www.cdt.org/standards/draft-ietf-enum-privacy-security-01.txt.

75 Tmdenton.com, "Privacy Issues in ENUM", 21 October, 2003, A study for Industry Canada
(www.tmdenton.com/pub/privacy_ENUM.pdf)

76 Roger Clarke, "ENUM, a Case Study in Social Irresponsibility", 2003,
(www.anu.edu.au/people/Roger.Clarke/DV/enumISOC02.html) and
Center for Democracy and Technology, "ENUM: Mapping Telephone Numbers onto the Internet, Potential Benefits with Public Policy Risks", April 2003 (www.cdt.org/standards/enum/030428analysis.pdf)

77 ENUM privacy considerations, Alexander Mayrhofer, presentation at 20th APAN Advanced Network Conference in Chinese Taipei, August 2005:
(www.apan.net/meetings/taipei2005/presentation/enum_bof/mayrhofer-privacy.pdf).

78 In most countries this is a natural result of compliance with the specific data protection legislation, but also as a result of deployment of specific policy such as Fair Information Practices.

79 To restrict or control access several technical solutions are developed, *e.g.* the PUA (Personal User's Agent). This filter is based on a proposal by ETSI (European Telecommunications Standards Institute) and can be build in ENUM databases to act as a sort of firewall. This filter controls incoming calls based on the caller's identity. For example, someone could route calls from family members to their mobile when they aren't home, but not calls from telemarketers. InternetNZ has released the source code for its prototype PUA to be used with a phone and Internet numbering system ENUM planned for trial.
(www.internetnz.net.nz).

80 "Threat Analysis of the Domain Name System " by the IETF Network Working Group,
<http://tools.ietf.org/html/draft-ietf-dnsext-dns-threats-07>.

81 DNSSEC (short for DNS Security Extensions) adds security to the Domain Name System. DNSSEC was designed to protect the Internet from certain attacks, such as DNS cache poisoning. It is a set of extensions to DNS, which provide: *a)* origin authentication of DNS data, *b)* data integrity, and *c)* authenticated denial of existence (www.dnssec.net).

82 Name servers are publicly accessible central computers that translate domain names to IP addresses. A multitude of name servers around the world perform this task for specific TLD's such as .com or .fr or underlying domains.